

waterman

# Assembly and Operating Instructions















English



Please read this manual carefully and  
keep it for future reference.

'Basic' Swimming Pools

**KURZANLEITUNG / QUICK START GUIDE / NOTICE SOMMAIRE / GUIDA RAPIDA  
BEKNOPTE HANDLEIDING / KORTFATTAD BRUKSANVISNING / STRUČNÁ  
PŘÍRUČKAG / STRUČNÝ NÁVOD / KRATKA NAVODILAG / GYORS ÚTMUTATÓ  
MANUAL CU INSTRUCȚIUNI PE SCURT**

**FOR ALL POOL TYPES**

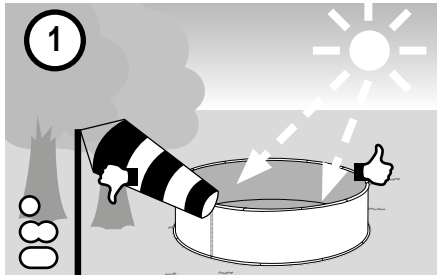

- (D)** Pool-Standort wählen
- (UK)** Selection of pool location
- (F)** Sélection de l'emplacement
- (I)** Scegliere il luogo per la piscina
- (NL)** Locatie zwembad kiezen
- (S)** Välja placering för bassängen
- (CZ)** Pool-volba místa
- (SK)** Zvoľte miesto inštalácie bazéna
- (SI)** Izbira mesta za postavljanje bazena
- (HU)** Medence helyének a kiválasztása.
- (RO)** Selectarea locului de amplasare a piscinei

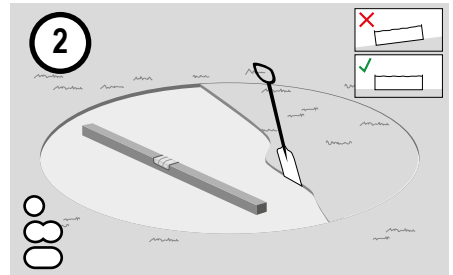

- (D)** Untergrund vorbereiten
- (UK)** Preparation of the foundation/ground
- (F)** Préparation du terrain
- (I)** Preparare il fondo
- (NL)** Ondergrond voorbereiden
- (S)** Förbereda underlaget
- (CZ)** příprava podkladu
- (SK)** Pripravte podklad
- (SI)** Priprava tal
- (HU)** Felállítási hely előkészítése.
- (RO)** Pregătirea solului de bază

## FOR SEMI-INGROUND/INGROUND INSTALLATION

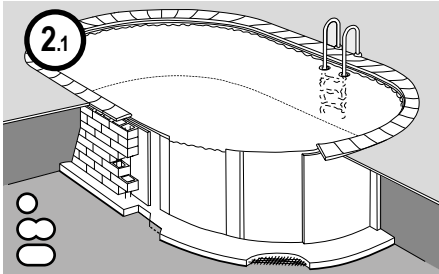

- Ⓓ Erdreich ausheben & Betonplatte gießen
- ⓊⓀ Excavation & Casting a concrete slab
- Ⓕ Excavation & Coulage de la dalle en béton
- Ⓘ Eseguire lo scavo e posare la base in calcestruzzo
- ⓃⓁ Grond verwijderen & betonplaat gieten
- Ⓐ Gräv ur marken & gjut en betongplatta
- ⒸⒿ Odkopat zemini vybetonovat základovou desku
- ⒶⓀ Vysadiť zemini & zaliat' betónovú dosku
- ⒶⓁ Zemiľo odstranite & vlijte betonsko ploščo
- ⒶⓂ Ássa ki az alapot & készítse el a betonlapot
- ⒶⓇ Excavare sol și turnare placă beton

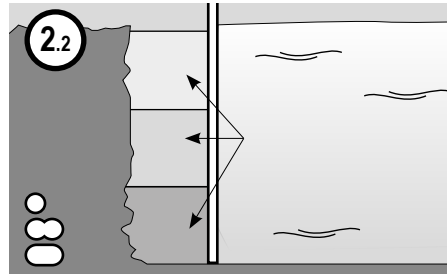

- Ⓓ Schichtweise Betonhinterfüllung
- ⓊⓀ Concrete backfilling in layers
- Ⓕ Remblai en béton par couches
- Ⓘ Riempiimento calcestruzzo a strati
- ⓃⓁ Beton laagsgewijs vullen
- Ⓐ Fyll på betong i flera skikt
- ⒸⒿ Betonovat po vrstvách
- ⒶⓀ Vo vrstvách zaliat' betónom
- ⒶⓁ Postopno v plasteh nanestite beton
- ⒶⓂ Lépcsőzetes betonozás
- ⒶⓇ Turnare beton umplutură laterală în straturi

## FOR FIGURE-8 SHAPED POOLS

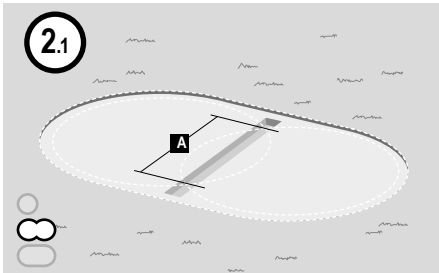

- Ⓓ Graben für Stahlträger
- ⓊⓀ Trench for steel girders
- Ⓕ Creusement pour poutre en acier
- Ⓘ Scavo per trave d'acciaio
- ⓃⓁ Greppel voor stalen drager
- Ⓐ Gräv ett dike för stålbalken
- ⒸⒿ Vykopat pro ocelový nosníky
- ⒶⓀ Jamy pre ocelové nosníky
- ⒶⓁ Luknje za jeklene nosilce
- ⒶⓂ Acélmerevítő alapja
- ⒶⓇ Gropi pentru montanții de oțel

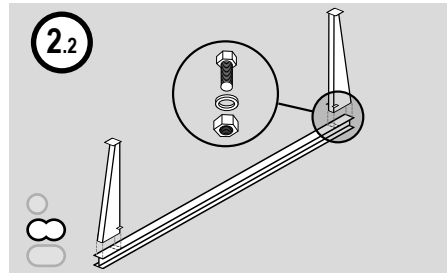

- Ⓓ Montage der Stahlstützträger
- ⓊⓀ Assembly of steel support beams
- Ⓕ Montage des jambes de force en acier
- Ⓘ Montaggio delle travi di sostegno in acciaio
- ⓃⓁ Montage van stalen steun
- Ⓐ Montera stålbalken
- ⒸⒿ Montáž ocelových nosníků
- ⒶⓀ Montáž ocelového podperného nosníka
- ⒶⓁ Montaža jeklenih nosilnih stebrov
- ⒶⓂ Acélmerevítő szerelése
- ⒶⓇ Montarea montanțiilor de oțel pentru reazem

## FOR OVAL POOLS

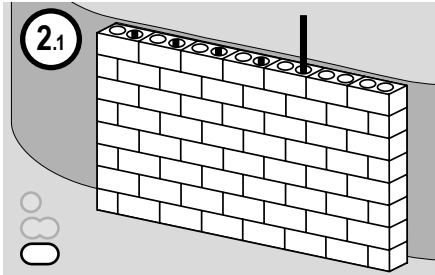

- Ⓓ Stützmauer errichten
- ⓊⓀ Construction of retaining wall
- Ⓕ Construction d'un mur de soutènement
- Ⓘ Costruire il muro di sostegno
- ⓃⓁ Steunmuur maken
- Ⓐ Bygg stödmuren
- ⒸⓏ Vybudovat opěrnou zeď
- ⒶⓀ Postaviť oporný múr
- ⒶⓁ Naredite podporni zid
- ⒶⓂ Támasztófal építése
- ⒶⓇ Ridicare ziduri susținere

## FOR ALL POOL TYPES

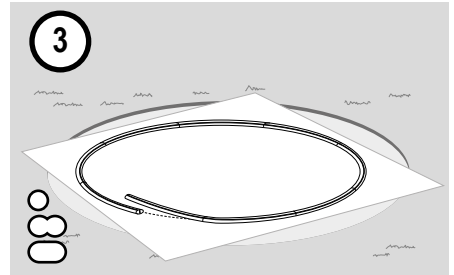

- Ⓓ Vlies und Bodenschienen auslegen
- ⓊⓀ Installation of floor protection fleece and seat rails
- Ⓕ Pose du tapis feutre et des rails d'assise
- Ⓘ Posare velo protettivo e profili inferiori
- ⓃⓁ Vlies en bodemrails uitleggen
- Ⓐ Lägga ut duk och bottenkenor
- ⒸⓏ uložení vlákny a dnových kolejnic
- ⒶⓀ Rozložte podložku a dnovú obruč
- ⒶⓁ Postavitev flisa in talnih tračnic
- ⒶⓂ Védőfólia és alap sínek elhelyezése.
- ⒶⓇ Amplasarea păturii drenante și șinelor bazei

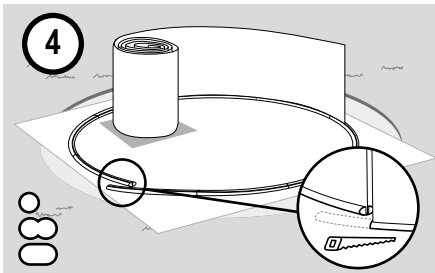

- Ⓓ Stahlmantel aufstellen
- ⓊⓀ Installation of steel wall (jacket)
- Ⓕ Mise en place de la paroi en acier
- Ⓘ Disporre la lamiera
- ⓃⓁ Stalen mantel opstellen
- Ⓐ Ställa upp stålmanteln
- ⒸⓏ stavba ocelového pláště
- ⒶⓀ Postavte ocelový plášť
- ⒶⓁ Postavitev pločevinastega plašča
- ⒶⓂ Fémfalást felállítása.
- ⒶⓇ Amplasarea mantalei de oțel

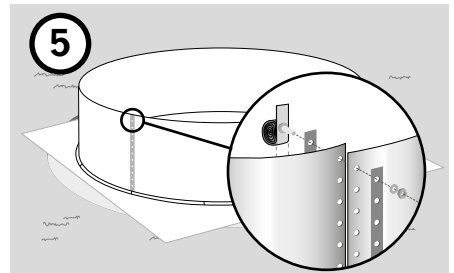

- Ⓓ Stahlwand verschrauben
- ⓊⓀ Assembly of steel wall
- Ⓕ Assemblage de la paroi en acier
- Ⓘ Avvitare la parete
- ⓃⓁ Stalen wand vastschroeven
- Ⓐ Skruva ihop stålväggen
- ⒸⓏ ocelovou stěnu spojit šrouby
- ⒶⓀ Zoskrutkujte ocelovú stenu
- ⒶⓁ Vijačenje pločevinastega plašča
- ⒶⓂ Fémfal összecsavarozása.
- ⒶⓇ Însurubarea peretelui de oțel



**Please observe the detailed instructions on the following pages.**

- Ⓓ Eine ausführliche Anleitung in Ihrer Sprache steht im Internet unter <http://download.waterman-pool.com> für Sie bereit.
- Ⓕ Une notice d'utilisation détaillée dans votre langue est disponible sur le site Internet <http://download.waterman-pool.com>
- Ⓘ Potete trovare la descrizione dettagliata nella vostra lingua in Internet all'indirizzo <http://download.waterman-pool.com>
- ⒹL Een uitgebreide handleiding in uw taal staat op internet onder <http://download.waterman-pool.com> voor u klaar.
- Ⓔ En utförlig anvisning på ditt språk finns att ladda ner på Internet under adressen <http://download.waterman-pool.com>
- ⒸZ Podrobné pokyny ve vašem jazyce jsou k dispozici na internetu jsou pro vás připraveny pod <http://download.waterman-pool.com>
- ⒺSK Podrobný návod vo vašom jazyku nájdete na internete na stránke <http://download.waterman-pool.com>
- ⒺSI celotna navodila v Vašem jeziku najdete na spletni strani <http://download.waterman-pool.com>
- ⒺHU Részletes útmutató az Ön beszélt nyelvéen az interneten a következő címen <http://download.waterman-pool.com> áll rendelkezésére.
- ⒺRO Un manual cu instrucțiuni detaliate vă stă la dispoziție pe internet pregătit în limba dumneavoastră la <http://download.waterman-pool.com>



**FOR FIGURE-8 SHAPED POOLS**

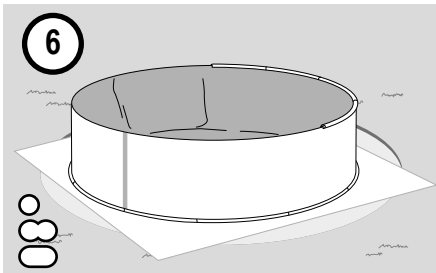

- Ⓓ Folie und Handlauf einhängen
- ⒺUK Attaching the liner and top rail
- Ⓕ Accrochage du liner et de la margelle
- Ⓘ Agganciare il liner e il profilo superiore
- ⒹL Folie en reling inhangen
- Ⓔ Installera folien och hållskenan
- ⒸZ Zavěšení folie a zábradlí
- ⒺSK Zaveste fóliu a držadlo
- ⒺSI Napenjanje folije in ročaja
- ⒺHU Fólia és felső sín behelyezése.
- ⒺRO Suspendedarea foliei și barei mână curentă

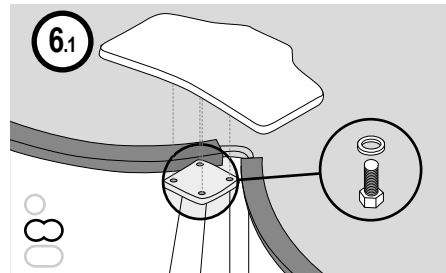

- Ⓓ Montage des Sitzboards
- ⒺUK Mounting the seat
- Ⓕ Montage du siège
- Ⓘ Montaggio panchina laterale
- ⒹL Montage van de bevestigings-board
- Ⓔ Montera sittbrädan
- ⒸZ Montáž sedačky
- ⒺSK Montáž sedadla
- ⒺSI Montaža sedeža
- ⒺHU Összekötő, felülő lemez szerelése
- ⒺRO Montarea banchetei

## ELECTRICAL SAFETY

- The power supply for your swimming pool must be protected by means of a residual current circuit breaker (30 mA).
- Never take electrical equipment into your swimming pool and never touch them from inside the water.



- Free-standing filter systems/pumps exceeding 12 volts must be installed with a minimum distance of 3 m from the pool, and a distance of 3.5 from the pool for the current source.
- Please observe the DIN VDE 0100 part 702 for all electrical installations of your pool.

## SAFETY OF NON-SWIMMERS

- A permanent, active and watchful supervision of weak swimmers and non-swimmers by a competent, skilled adult supervisor is necessary at all times (it should be remembered that the greatest risk of drowning is among children under 5 years of age).
- A competent, skilled adult is appointed to monitor the pool when it is used.
- Weak swimmers or non-swimmers must wear personal protective equipment when using the swimming pool.
- If the pool is not used or monitored, all toys must be removed from the pool and its surroundings to prevent that children are attracted by these.

## SAFETY INSTRUCTIONS AND WARNINGS

The use of a swimming pool kit presumes that the construction kit complies with the safety regulations described in the operation and maintenance manual. To prevent a drowning of children, it is recommended to secure access to the swimming pool. The access to the pool is to be secured in such a way that children under 5 years cannot get into the pool water unnoticed. You can protect the pool with a childproof fencing or a childproof cover/roofing of the complete pool, with an additional alarm system, if desired. Safety devices can make a pool safer, but never replace a permanent supervision of children by an adult who can help in an emergency.



While the pool is used, no equipment used to access the swimming pool (e.g. ladders) must be removed. When the pool is no longer used, ladders must either be completely removed from the pool or secured in such a way that unauthorized access is not possible (for example, we recommend using a safety ladder with detachable, or foldable and lockable steps).

## SAFE USE OF THE SWIMMING POOL

- Dives into the pool are not allowed, never jump into shallow water (danger of serious injuries or even death).
- Learn first aid skills (cardiopulmonary resuscitation CPR) and refresh your knowledge regularly. This can make a lifesaving difference in an emergency.
- All pool users, including children, are to be instructed what to do in an emergency.
- Remove protecting covers completely before using the pool, never dive under covers.
- Place the ladder to enter the swimming pool on a secure, firm floor. Check regularly that all connections are still firmly and properly fixed, and that there is no damage.
- Never use the swimming pool when under the influence of alcohol, drugs, or medication.
- Never mix water treatment chemicals, keep chemicals for the swimming pool securely closed and out of the reach of children.
- Never allow swimming alone; children or non-swimmers may only use the pool under supervision and, if necessary, with swimming aids. All users, especially children, are encouraged to learn how to swim.
- Please use the enclosed safety labels and fix them in a clearly visible place in the area of your swimming pool (within 2000 mm).
- Place life-saving equipment (bars, safety buoys, first aid emergency numbers) near the pool.
- Ensure a regular measurement of pH and disinfectant levels, since this is the only way you can prevent the spreading of germs (bacteria, viruses, etc.) in the water. Please have a shower before and after swimming. Never enter or jump into the water when you are overheated.
- Never sit down on the edge of the pool and do not cause excessive water movement, especially in case of free-standing pools.
- Avoid running around the swimming pool (danger of slipping).
- Never allow animals (dogs, cats, fish) to swim in your swimming pool.
- Never use the pool in the dark or in dangerous weather (lightning, thunder, thunderstorm).
- Never swim or dive between the ladder and the pool wall (danger of getting trapped).
- Keep a working phone and a list of emergency numbers near the swimming pool.
- Never climb directly out of the pool, always use the ladder. Excessive pressure and kicks against the pool wall can cause damage to or breakdown of the swimming pool. Never sit on the basin edge/top rail.
- Do not use any sharp-edged cleaning devices or toys, which could damage the lining (inside).
- Check all screw connections on a regular basis and ensure that there are no sharp-edged corners or edges on the pool or accessories (e. g. ladders) that could cause a risk of injury.





## PURCHASE INFORMATION / TECHNICAL DATA ROUND POOLS

**Note:**

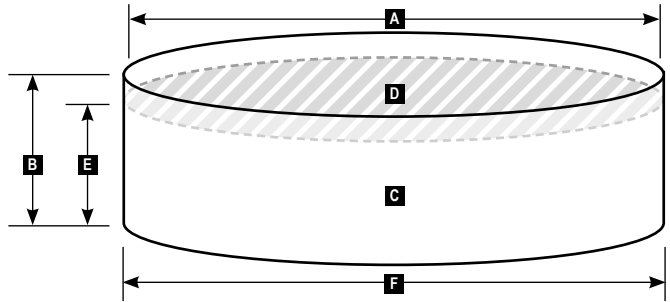
This pool conforms to the EN16562-1 standard. It is supplied as above-ground pool kit.



<b>A</b> Diameter (m)	<b>B</b> Height (m)	<b>C</b> Volume (l)	<b>D</b> Water surface	<b>E</b> Max. depth of water	<b>F</b> Max. outer dimension	 Time required for setup (excl. concrete)	 No. of people required for setup
3.00	0.90	6,000	7 m <sup>2</sup>	0.80m		2h	2 - 3
3.50	0.90	8,000	9.6 m <sup>2</sup>	0.80m		2h	2 - 3
4.00	0.90	9,000	12.5 m <sup>2</sup>	0.80m		2.5h	3
3.00	1.10	7,350	7 m <sup>2</sup>	1.00m		2h	2 - 3
4.00	1.10	12,850	12.5 m <sup>2</sup>	1.00m		2.5h	3
5.00	1.10	20,500	19.5 m <sup>2</sup>	1.00m		3h	3
3.00	1.20	8,000	7 m <sup>2</sup>	1.10m		2h	2 - 3
3.50	1.20	11,000	9.6 m <sup>2</sup>	1.10m		2h	2 - 3
4.00	1.20	14,000	12.5 m <sup>2</sup>	1.10m		2.5h	3
4.20	1.20	15,000	13.5 m <sup>2</sup>	1.10m		2.5h	3
4.50	1.20	18,000	16 m <sup>2</sup>	1.10m		2.5h	3
5.00	1.20	22,000	19.5 m <sup>2</sup>	1.10m		3h	3
5.50	1.20	26,000	23.7m <sup>2</sup>	1.10m		3h	3

Pool size + 5 cm



**PURCHASE INFORMATION / TECHNICAL DATA FIGURE-8 SHAPED POOLS**

**Note:**

This pool conforms to the EN16562-1 standard. It is supplied as above-ground pool kit.

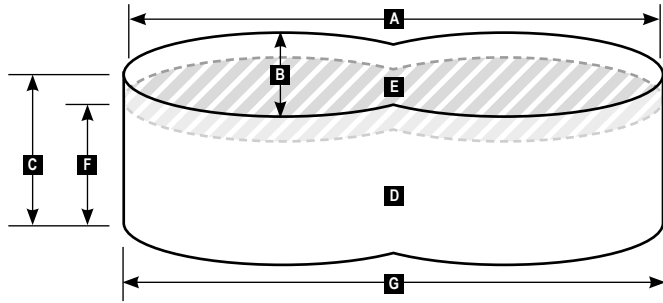

A	B	C	D	E	F	G	⌚	👤
Length (meter)	Width (meter)	Height (meter)	Volume (liters)	Water surface	Max. depth of water	Max. outer dimension	Time required for setup (excl. concrete)	No. of people required for setup
4.70	3.00	1.20	13,000	11.3 m <sup>2</sup>	1.10m	Pool size + 5 cm	3.5h	3
5.25	3.20	1.20	16,000	14.0 m <sup>2</sup>	1.10m		3.5h	3
5.40	3.50	1.20	18,000	15.75 m <sup>2</sup>	1.10m		3.5h	3
6.50	4.20	1.20	25,000	21.5 m <sup>2</sup>	1.10m		3.5h	3

**PURCHASE INFORMATION / TECHNICAL DATA OVAL POOLS**

**Note:**

This pool conforms to the EN16562-1 standard. It is supplied as above-ground pool kit.

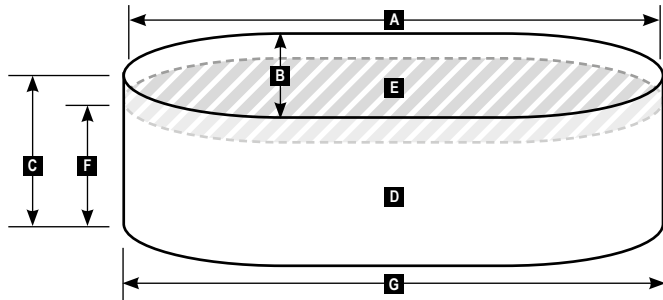

A	B	C	D	E	F	G	⌚	👤
Length (meter)	Width (meter)	Height (meter)	Volume (liters)	Water surface	Max. depth of water	Max. outer dimension	Time required for setup (excl. concrete)	No. of people required for setup
4.90	3.00	1.20	14,000	12.5 m <sup>2</sup>	1.10m	Pool size + 5 cm	3h	3
5.25	3.20	1.20	17,000	15 m <sup>2</sup>	1.10m		3h	3
6.00	3.20	1.20	19,000	17 m <sup>2</sup>	1.10m		3.5h	3
6.23	3.60	1.20	21,000	18.5 m <sup>2</sup>	1.10m		3.5h	3

---



---

Use Above ground pool, semi-inground pool, inground pool

---

Assembly kit type Above ground pool kit

---

Water resistance classification WO: 0 lt

---

Tools required for setup:

- Straightedge
- Water level
- Spade / Shovel
- Rubber mallet
- Vibrating plate, if required
- Hack saw
- Folding rule
- Flat blade screwdriver
- 10 mm ring spanner
- Cord
- Peg
- Marking spray or bottle of flour

---

Tools necessary for concrete work are not listed.

---

Material required in addition

- Floor protection fleece
- Water care products

---

Useful accessories

- Floor vacuum cleaner
- Scoop
- Protecting cover
- Dosing float
- Water tester
- Lighting

---

Enclosed safety labels



Be aware of the risks of diving.



Children must be supervised by adults at all times.



Danger. Risk of drowning.

---



## Important information to be observed before assembly

Thank you for purchasing a quality product from Waterman. Our 'Basic' pools profit from decades of know-how, which has deepened over the years. Our production facilities for these pools are located in the Alsace, close to the German border. Our employees at our

headquarters in Wendlingen am Neckar (near Stuttgart) constantly check and further develop the technology. Please read these instructions carefully, and do not hesitate to contact us directly in case of questions.

### CHOOSING A LOCATION

Please clarify first if the selected swimming pool can be built at the chosen location without a building permit and without further official formalities. Please take into account that there must be no pipes (gas, water, electricity, telephone, etc.) in the installation area of your new swimming pool. Built-in swimming pools (inground, semi-inground) must not be installed in the area of strata water or ground water.

- Sunny location:** We recommend to select a location that provides a maximum of solar radiation per day.
- Trees:** There should be no trees in the immediate vicinity of the pool, since they may cause pollution (foliage, needles, pollen) and excess shading.

- Wind:** Use the main wind direction in such a way that dirt that falls on the water surface is driven towards the skimmer.
- Logistics/neighbours:** To operate your swimming pool, you need electricity (protected by a residual current circuit breaker), water to refill, and a sewage connection/sewer pipe. You should place the pool as close to the house as possible, if necessary next to the terrace. However, you should always ensure that technical problems will not result in damage to the house (e.g. leaking water flowing into the basement). Be also careful that neighbours are not disturbed excessively, and ensure that the site is well protected (privacy), if possible.

### CHOOSING THE RIGHT ACCESSORIES

There are number of useful accessories for your swimming pool, some of which are difficult or impossible to retrofit. This primarily includes all built-in parts such as floor drain (which contributes significantly to an improved water circulation), additional inlet nozzles, submersible floodlights for recessed installation, integrated countercurrent

systems, etc. Other components can be installed later (e.g. solar power system, heat pump, safety cover, etc.). It is advisable, however, to consider what you may want to add later at the time when the pool is initially installed.

## WATER CIRCULATION

Our steel wall pools are delivered as standard with a skimmer press-cut (suitable for mini-skimmer, rectangular, approx. 148 x 140 mm) and a 60 mm round cut for 1 inlet nozzle, which is located approx. 80 cm next to it. Holes for other built-in parts must be cut/punched on site during the assembly of the pool.

Depending on the shape of the pool (in particular for larger oval and figure-8 shaped pools), a second inlet nozzle can be installed to improve the water circulation (which may also save water treatment agents), or you can place the two discharge nozzles

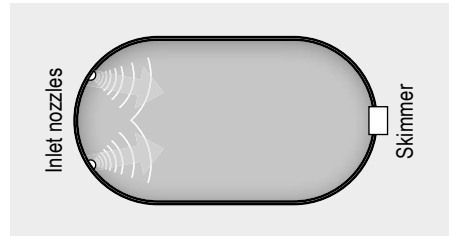

on the the opposite side of the skimmer (with a T-fitting between the two).

## FILTER SHAFT

Especially for inground swimming pools it is advisable to build a filter shaft (e.g. made of bricks). Advantage: filter system and other technical components are not visible. It also provides a good noise insulation, and the filter system is protected from the weather. However, it is important to provide a good drainage (including sewer connection) so

that even in the event of an unplanned heavy rainfall or a defect in the filter system, the filter system/ electrical connections cannot be flushed over. A good ventilation of the filter shaft prevents corrosion damage and should be taken into account during the planning.

## PIPING

As standard, our pools are delivered with a 38 mm swimming pool hose. This hose must not be laid directly in the ground. In case of an inground installation, we recommend to place this hose in a conduit. Alternatively, many swimming pool builders use a fixed piping or a 50 mm glued hose. The advantage of this is that the pipes are more stable, and the smooth inside and the larger diameter

reduce the flow resistance, which has a positive effect on filter performance/water flow (contact your dealer, if necessary/we can also offer an alternative piping for your pool). When laying the hose or piping as well as skimmer and inlet nozzles, ensure that these parts are easily accessible in case of a defect, so that they can be replaced if necessary.

# Pool setup (round pools)

Before setting the pool up, check that all required parts are available according to the attached parts list:

Swimming pool diameter/depth	Pack of profile rails Top rail Q2 Bottom rail Q2	Liner with J-hook	Steel wall with perforation and 2 fastening rails	Screw set and screw cover	Grounding kit
Ø 300 cm x 90 cm	1	1	1	1	1
Ø 350 cm x 90 cm	1	1	1	1	1
Ø 400 cm x 90 cm	1	1	1	1	1
Ø 300 cm x 110 cm	1	1	1	1	1
Ø 400 cm x 110 cm	1	1	1	1	1
Ø 500 cm x 110 cm	1	1	1	1	1
Ø 300 cm x 120 cm	1	1	1	1	1
Ø 350 cm x 120 cm	1	1	1	1	1
Ø 400 cm x 120 cm	1	1	1	1	1
Ø 450 cm x 120 cm	1	1	1	1	1
Ø 500 cm x 120 cm	1	1	1	1	1
Ø 550 cm x 120 cm	1	1	1	1	1

## THERE ARE 3 DIFFERENT MOUNTING OPTIONS

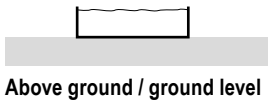

**Above ground / ground level**



**Semi-inground**  
(Attention, the built-in part of the pool requires a lean concrete backfill.)



**Completely inground**  
(Possible only with a lean concrete backfill (20 – 30 cm.) The pool must always be filled with water, never leave without water for a longer period.

## PREPARATION OF FOUNDATION FOR ROUND POOL

The best substrate for your swimming pool is a concrete slab (thickness approx. 20 cm), which must be perfectly level (terraces, paved areas, etc. are critical/not suitable, since they use slopes).

1. Mark the required floor space by driving a pole in and drawing a circle with a cord and marking spray or flour bottle.

Alternatively, you can do without a concrete slab in case of small round pools if you take the following into account:

2. Remove grass, ground cover/plant cover, and roots completely.
3. Excavate soil until the ground is perfectly level (never backfill and do not use sand to fill up). The ground must be perfectly level, with a max. deviation = 1 cm on the entire floor space, load bearing capacity of the ground at least 1.2 tons (with a pool depth 1.20m) or 1 ton (with a pool depth 0.90m).

The pool must be set up on natural ground, never on a slope. Please compact the ground with a vibrating plate. The diameter of the installation place for the pool should exceed the actual pool diameter by at least 20 cm. In case of an inground installation, adjust the cord length according to the wall backfill (in case of ground pressure, we recommend a 30 cm lean concrete backfill).

### Installation floor drain (optional/not included):

You can install a floor drain in addition to the skimmer. This will result in an improved pool hydraulics/recirculation of the pool water. When installing a floor drain a concrete slab is required, which should ideally be slightly lowered in the middle, towards the floor drain.

Dimensions swimming pool	Length of cord
300 cm	160 cm
350 cm	185 cm
400 cm	210 cm
500 cm	260 cm

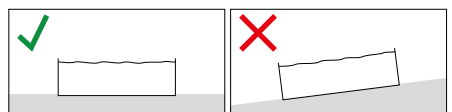
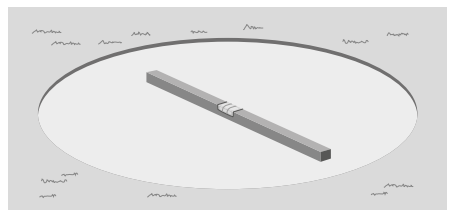
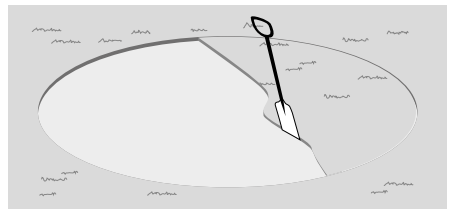
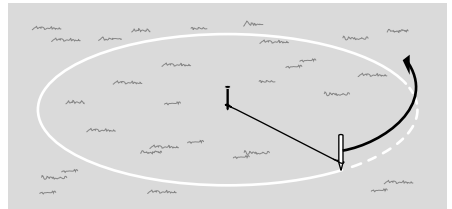

550 cm

285 cm

Use the suction function of the floor drain only when the pool is not used (no bathers), since otherwise there is a risk of suction to the floor.

## INSTALLATION FLOOR PROTECTION FLEECE

After the foundation has been properly prepared and the substrate is perfectly level, you must cover the ground with a synthetic floor protection fleece (not included in the delivery). Please clean the surface thoroughly once again and remove all stones/unevenness, which could be dangerous for the liner.

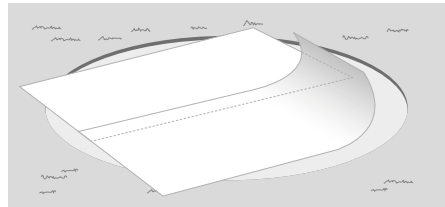

Place the fleece either end-to-end and secure with double-sided adhesive tape, or allow it to overlap (i.e. covering the edges). The fleece should exceed the pool dimensions by about 10 cm on the outside (if no protective fleece is used, there is no warranty on the liner).

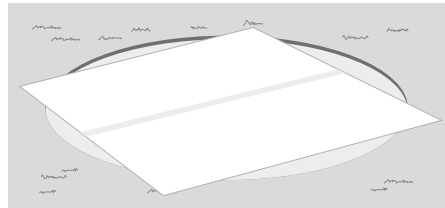

## ASSEMBLING THE BOTTOM RAILS

The next step is assembling the bottom rail segments with the connecting tubes. Please note that the bottom rails must be shortened to the length of the steel wall. For oval and octagonal pools, we recommend that the shortening is carried out halfway on both sides of the curve so that the geometry of the pool is not deformed.

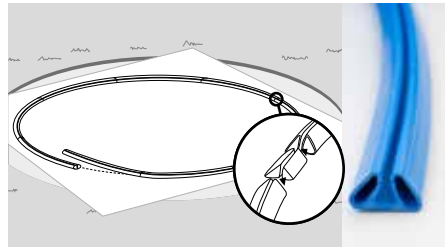

## STEEL WALL SETUP

Do not set the pool up in case of strong winds. There should be at least 3 people to help so that the steel wall does not bend/tilt over. To stabilize the wall during assembly, the top rail segments can be temporarily attached on the top of the raised steel wall. Please wear protective gloves as the steel wall can have sharp edges. Place the steel wall on a wooden board and carefully roll it apart. Insert the steel wall into the bottom rails (white side outwards). It may be helpful to push the bottom rails into the steel wall from below with a board. Ensure that the skimmer pre-cut is located at the top of the metal wall (it becomes visible after having unrolled about 1 meter of the steel wall) is at the top of the steel wall. Remove the skimmer cut by breaking it away.

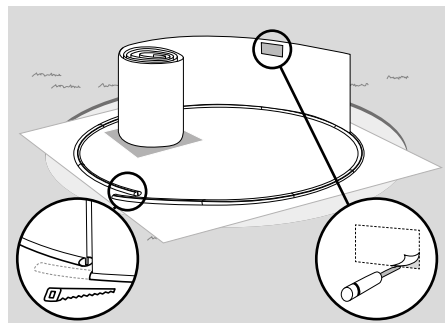

## CONNECTION OF STEEL WALL ENDS (TO BE SCREWED TOGETHER)

The ends of the steel wall overlap, so that the holes of the two steel wall ends are exactly on top of each other. Two additional 2 stabilizer bars included to stabilize the wall. One of these bars must be fitted from the inside and one from the outside (see image). Insert the screws with screw heads on the inside of the wall, then attach a washer first and then a nut on each screw from the outside (tighten firmly with a 10 mm ring or fork wrench). To avoid damage to the liner later on, it is imperative to cover/pad the screw heads with thick package or insulation tape (not included in delivery). Finally, attach the blue protective cover (guardrail) on the screw heads (plugged in from the outside) so that the screw ends cannot cause any injury.

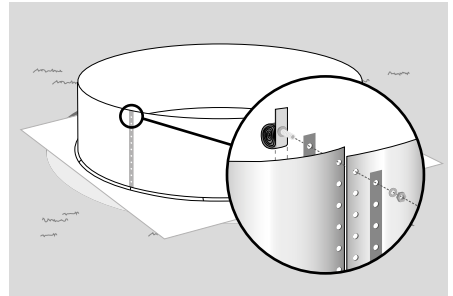

### Important :



Tighten all screws firmly and check them regularly. Loose screws may cause a crack in the steel wall.

## GROUNDING THE SWIMMING POOL (EQUIPOTENTIAL BONDING)

Drill a  $\varnothing$  5 mm hole into the steel wall, just above the bottom rails. Attach the enclosed grounding kit (see drawing) and connect the cable to an approx. 30 cm long metal earth spike (not included in delivery) which you anchor in the ground. In case of a concrete backfill, place the grounding through this into the ground. In case of above ground pools, drive the earth spike completely into the ground so that it cannot cause any injuries.

Attention: According to DIN/VDE regulations,

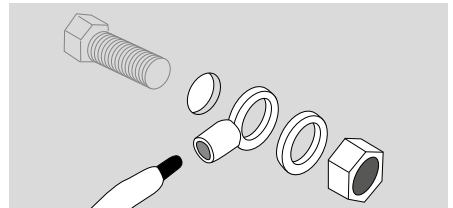

electrical installations may only be carried out by authorized specialist companies.

## ASSEMBLY OF OTHER COMPONENTS

Before attaching the liner, cut/punch all holes required for the assembly of other built-in parts (e.g. second inlet nozzle, floodlights, countercurrent

systems etc.) into the steel wall, carefully remove all chips and metal parts and protect the cutting areas with a zinc spray from rust.



**LINER INSTALLATION/ASSEMBLY:**

We recommend unpacking and unrolling the liner one day before assembly. In this way, wrinkles from transport are avoided. Handle the liner with utmost care (never walk on it with shoes, do not drag/pull over the floor, etc.). The manufacturer does not assume liability for any mechanical damage that occurs during assembly. Please also pay attention to the possible presence of metal chips and residual dirt, and remove these completely before assembling the liner.

Please note that the PVC liner of your swimming pool is made undersized, so there will be no wrinkles inside the pool later. The liner must therefore be installed at an outside temperature of about 20 to 25°, since it is at this temperature that it is most expansible and flexible. The liner must never be placed without floor protection fleece (felt mats), never directly on polystyrene or other materials, as these may cause irreparable damage to the liner, for example due to the removal of plasticizers.

Since the liner is always slightly smaller than the pool, it is partly necessary to pull the liner with force to hook it in. Since the liner is always slightly smaller than the pool, it is partly necessary to pull the liner with force to hook it in. Do not be afraid to pull it, the liner has a stretching capacity of over 10%.

First put the liner in the middle of the pool and then unfold it. In case of figure-8 shaped and oval pools, begin assembling the liner in the middle and slowly work your way to both outer sides of the pool. Pay attention to the vertical liner weld; it must never be in the area/at the level of components (skimmer, inlet nozzle, etc.), as otherwise it would not seal properly at this point.

The liner is now hooked to the top of the steel wall with the help of the J-bead (this is a reinforcement bead welded to the top edge of the liner). You can temporarily fix the liner, for example with clothes pegs, while you are still aligning it.

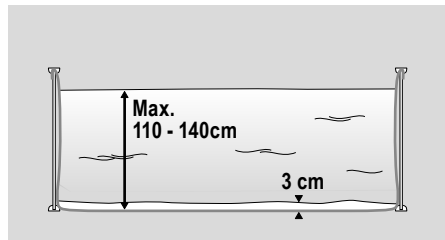

At first, fill only the basin only with about 1 to 2 cm water. After the liner has been installed on the outer steel wall, check if the water level has increased evenly everywhere. If this is not the case, the pool is sloping and it is necessary to adapt/correct the foundation/subsoil (check this once again when the pool is completely/partly filled, the soil may partially settle under the weight of the water).

Next align the liner and push all remaining wrinkles outwards towards the steel wall. Note that wrinkles can only be removed if there is a maximum of 3-5 cm of water in the pool; with a higher level it is no longer possible to remove wrinkles due to the pressure of the water.

Use only tap water and never use well water (to avoid problems with the water quality/brown water).

## ASSEMBLY OF TOP RAIL (QUALITY Q2):

They are assembled after the liner has been installed without wrinkles. The individual top rail segments are connected with the connecting sleeves and at the end, just like the bottom rails before, the last section is cut to the correct length of the steel wall. Ensure that the individual top rail segments are fitted firmly and correctly together so no gaps between the segments are visible later on. Since the Q2 top rail is manufactured with a very narrow grip to ensure a firm fit on the steel wall, we recommend to carefully tap it together with a rubber mallet.

For the handrail please use the wider Profile (quality Q5, see photo).



## ASSEMBLY OF COMPONENTS:

All installation parts (skimmers, inlet nozzles, headlights, etc.) may only be installed after the water level has risen to just below the steel wall

cut-out. Otherwise there may be tears in the liner or leakage may occur if the water level is raised later on and the liner would be lowered again as a result.

## CONCRETE BACKFILL

In case of inground pools, a lean concrete backfill is mandatory (20 cm/for extra pressure by soil = 30 cm). To this end, use a gravel-cement mixture (grain size 0 to 8) in a ratio of 8:1 earth-moist. The concrete backfill must run along the entire installation area of the pool, otherwise there is a danger that the ground soil will press the pool wall in when replacing the water. First place/glue a waterproof Styrodur (polystyrene) panel (about 2 cm thick) from the outside in front of the steel wall (for thermal insulation and protection of the steel wall), and then fill in lean concrete in layers in the space between the basin and the soil. The water level in the pool should always be about 30 cm higher than the backfill. Under no circumstances compact the lean concrete or use a concrete pump. Fill layers of approx. 30 cm with lean concrete, then wait for at least 1 day (hardening) before filling the next layer.

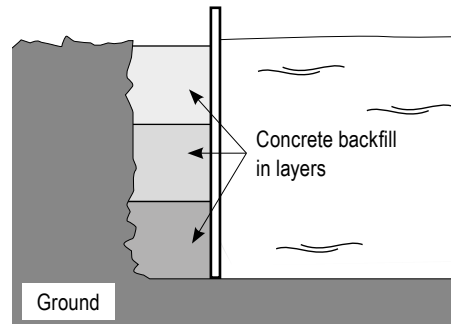

# Pool setup (figure-8 shaped pools)

Before setting the pool up, check that all required parts are available according to the attached parts list:

Swimming pool external dimensions/depth (m)	Pack of profile rails Top rail Q2 / Bottom rail Q2	Liner	Seat pack	Pair of supports (2-piece)	Base support 2048 mm with end flange (M33362)	Base support 1738 mm with angled joint bars (M89315)	Base support 2980 mm one-piece (M89300)	Screw package and screw cover strip	Steel wall with perforation and 2 fastening rails	Grounding kit
4.70 x 3.00 x 0.90	1	1	1	1			1	1	1	1
4.70 x 3.00 x 1.20	1	1	1	1			1	1	1	1
5.40 x 3.50 x 1.20	1	1	1	1		2		1	1	1
6.50 x 4.20 x 1.20	1	1	1	1	2			1	1	1

Also check the length of the supplied steel girders carefully before embedding them in concrete.

## THERE ARE 3 DIFFERENT MOUNTING OPTIONS

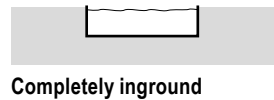
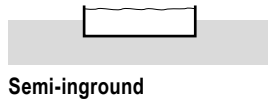
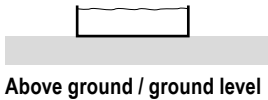

## PREPARATION OF GROUND FOR FIGURE-8 SHAPED POOLS

The best substrate for your swimming pool is a concrete slab (thickness approx. 20 cm), which must be perfectly level (terraces, paved areas, etc. are critical/not suitable, since they use slopes).

1. Mark the floor space by driving two pegs in at distance A (see table), and draw two circles with a cord (length see table) and a marking spray or flour bottle:

We recommend to install your Basic figure-8 swimming pool on a concrete slab with iron reinforcement (thickness 20 cm). It is imperative that the ground has a load bearing capacity of at least 1.2t (pool depth 1.20 m) or 1.0t (pool depth 0.90 m). The ground must be perfectly level, with a maximum deviation of 1 cm on the entire floor space of the pool. With larger deviations, you risk the collapse of the entire pool.

The diameter of the installation area for the pool should be at least 20 cm larger than the pool size (see cord length according to table). In case of an inground installation, adapt the backfill of the wall (in case of pressing soil, we recommend a 30 cm lean concrete backfill). In this case, increase the cord length by 10 cm (according to table).

It is mandatory to provide a trench with a width of 240 mm and a depth of 255 mm in the middle of the concrete slab. This is where the steel slab will be recessed and fixed with concrete later. (For length of the trench, see table on next page.)

The steel girder is flush-mounted into the base plate (approx. 22.5 cm, up to the height of the fixing straps of the bottom rail connecting pieces).

Dimensions swimming pool	Cord length "R"	Distance "A"
470 x 300 cm	170 cm	170 cm
540 x 350 cm	195 cm	190 cm
650 x 420 cm	230 cm	230 cm

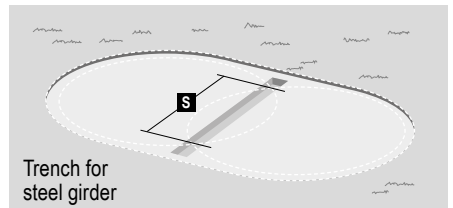
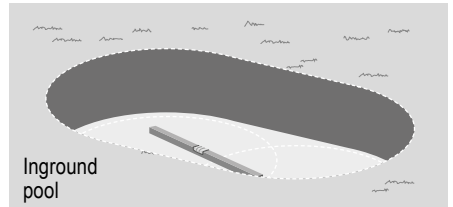
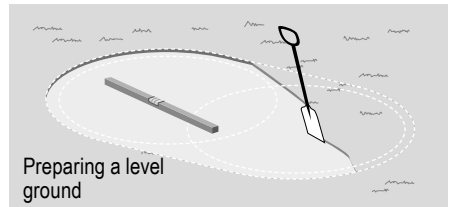
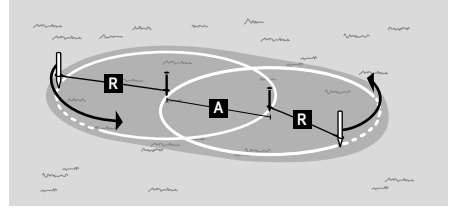

## MOUNTING THE STEEL SUPPORT BEAMS

Depending on the pool size, different steel girders are required for your swimming pool (see parts list). Please assemble the steel girders belonging to your pool in accordance with the following drawings. Ensure that all screw connections are absolutely tight and secure.

Dimensions swimming pool	Trench length	Distance between supports "S"
470 x 300 cm	320 cm	248.0 cm
540 x 350 cm	370 cm	297.5 cm
650 x 420 cm	440 cm	359.6 cm

Please check the distance between the fully assembled supports once again with the help of the following table. The table also shows the required trench dimensions for embedding the supports.

## MOUNTING AND FIXING THE STEEL SUPPORT BEAMS

Place the pre-assembled support units in the trench. Align the support unit exactly vertically. Embed the concrete slab with concrete at ground level (installation depth approx. 22.5 cm) so that the fishplates for fixing the bottom rails are flush with the top edge of the concrete slab.

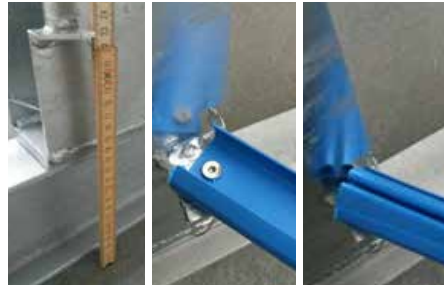

Installation depth of steel girder (approx. 22.5 cm)

Installation of bottom rail connector

Attaching the bottom rail to the steel girder

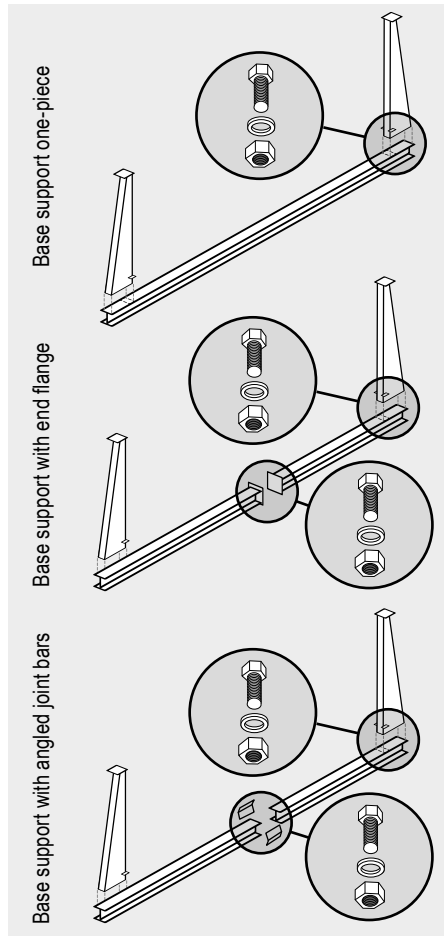

## INSTALLING THE FLOOR PROTECTION FLEECE AND THE BOTTOM RAILS

After the substrate has been prepared, spread out the floor protection fleece (not part of delivery for every pool). Either allow the edges to overlap (which may be visible through the liner) or place the fleece end-to-end and fix it from below with double-sided adhesive tape. Then assemble the bottom rails by plugging them into the connectors. Always start with the bottom rail connectors on the steel girder. The correct length of the bottom rails can only be determined after the steel wall has been adjusted; the bottom rails must be shortened accordingly, if required.



**Attention:** For figure-8 shaped pools, we always deliver 2 complete sets of bottom rails for the respective round pool size (e.g. for a figure-8 shaped pool 470 x 300 cm, we deliver 2 sets of bottom rails 300 cm round), so you always have a few segments left.

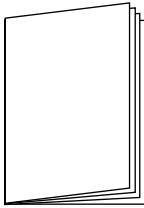
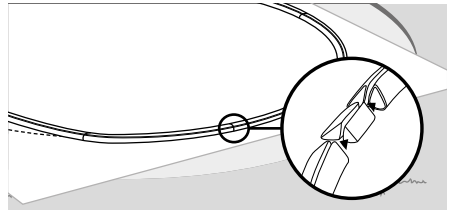
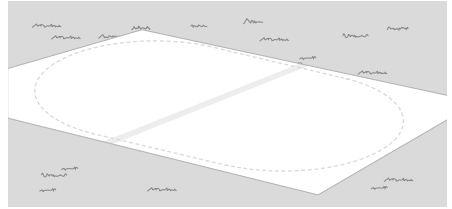
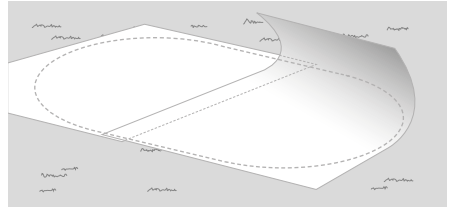

## STEEL WALL SETUP INSTALLATION OF LINER TOP RAIL & CONCRETE BACKFILLING

All further assembly steps and prescribed regulations are the same as for round pools. Please continue reading on page 15 of this manual.

## ASSEMBLING THE SEATS

Finally, screw the enclosed seats on top of the steel girders:

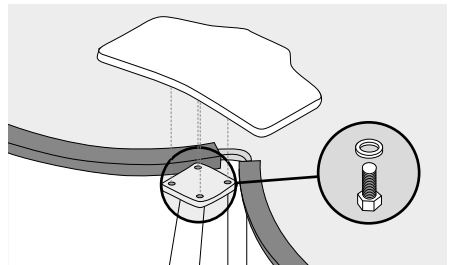

# Pool setup (oval pools)

Before setting the pool up, check that all required parts are available according to the attached parts list:

Swimming pool diameter/depth	Pack of profile rails Top rail Q2 Bottom rail Q2	Liner with J-hook	Steel wall with perforation and 2 fastening rails	Screw set and screw cover	Ground- ing kit
490 x 300 x 120 cm	1	1	1	1	1
623 x 360 x 120 cm	1	1	1	1	1



**Attention:** Oval basins may only be installed as (complete) inground pools.

An above-ground installation is not possible for static reasons. Never build landfills in case of slopes. Slopes must be levelled by means of excavation. Slopes must be supported

by retaining walls, or be strongly flattened.

Under no circumstances can the basin support a slope. In case of accumulating groundwater or layer groundwater, a drainage must be provided. The excavation pit must not be located in the groundwater area.

## DIMENSIONS OF EXCAVATION

For a pool depth of 1.20 m, the excavation should be at least 100-120 cm deep (plus the additional depth required for the floor/concrete slab).

The soil/ground floor in the excavation area must meet the static requirements. It must be natural soil

and never consist of backfilled soil. The dimensions of the excavation pit are shown in the following drawing/table.

## CASTING THE CONCRETE SLAB

We recommend that you use an approx. 15 cm thick layer of gravel underneath the concrete slab as drainage/frost blanket. The concrete slab should be at least 10 to 15 cm thick and should in any case be reinforced with an iron reinforcement/ steel fabric mat (Q188 A). In the area where the retaining walls are to be built, integrate additional iron reinforcements/round iron bars, which will later connect the concrete slab and the lateral retaining walls. The concrete slab must have an additional depth of at least 16 cm in the area where the retaining walls will be built later (this means a total depth of approx. 31 cm).

Dimensions swimming pool	"A"	"B"	"C"
490 x 300 cm	360 cm	540 cm	230 cm
623 x 360 cm	420 cm	673 cm	320 cm

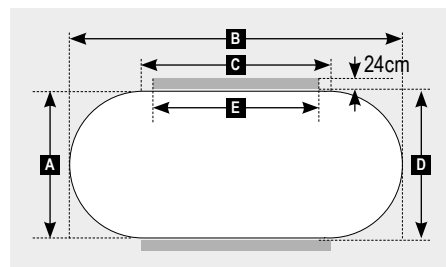

### CONSTRUCTION OF THE LATERAL RETAINING WALLS

After the concrete slab has hardened, the side retaining walls are built (see table on the right for dimensions). These walls are built using either hollow blocks to be filled with concrete or, for example, prefabricated blocks or concrete blocks with a thickness of 24 cm. It is important that the bricks are reinforced with 8 mm iron bars (see drawing), and are completely cast with concrete. Build the walls with staggered blocks.

Observe the drying time for the used concrete; this can be up to 21 days depending on type and quality. You can only begin with the further installation of the swimming pool after the concrete has completely hardened. It must always be observed that the side retaining walls must be completely recessed in the compacted soil; they must never be freestanding. The rounded parts at the ends of your oval pool must later be filled with a lean concrete backfill over the full depth (in filling steps of 20 to 30 cm, depending on the condition of the soil).

Dimensions swimming pool	Wall spacing "D"	Wall length "E"
490 x 300 cm	304 cm	190 cm
623 x 360 cm	364 cm	263 cm

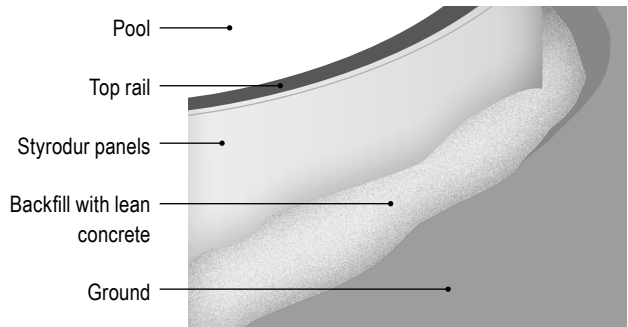
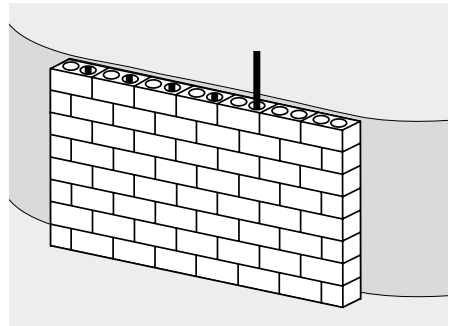
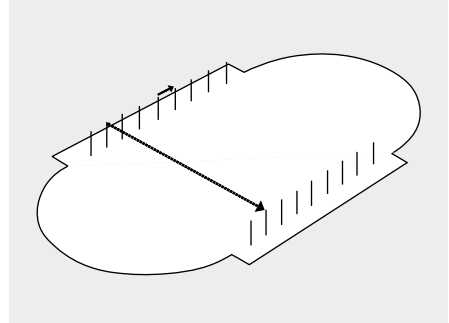



## FIXING THE STEEL WALL TO THE RETAINING WALL

After the steel wall has been set up, it must be fastened to the side retaining wall in the upper area (approx. 10 cm below the top rail) with dowels and countersunk head screws. Depending on the size of the pool, we recommend to place 1 dowel (6 mm) each at a distance of 50 cm and to fix the steel wall with a countersunk head screw. Following this, pad the screw heads with a PVC-compatible adhesive tape (not included in the delivery) from inside the pool to protect the liner.

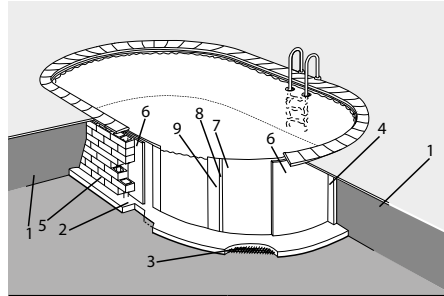

- |   |                          |
|---|--------------------------|
| 1 = Ground                              | 5 = Retaining wall       |
| 2 = Concrete slab                       | 6 = Styrodur panel 20 mm |
| 3 = Iron reinforcement of concrete slab | 7 = steel wall           |
| 4 = Concrete backfill                   | 8 = Interlocking profile |
|   | 9 = Liner                |

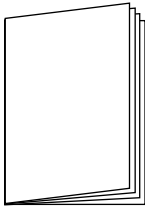

### STEEL WALL SETUP INSTALLATION OF LINER TOP RAIL & CONCRETE BACKFILLING

All further assembly steps and prescribed regulations are the same as for round pools. Please continue reading on page 15 of this manual.

# Maintenance and servicing of your swimming pool

## MECHANICAL AND CHEMICAL WATER TREATMENT

To remove all dirt particles falling into the water and to ensure a proper circulation, it is necessary to connect a filter system to your swimming pool. The system is connected via a built-in skimmer and the cleaned water is recirculated via the inlet nozzle. In addition, it is imperative to ensure a proper chemical water treatment. This means it is necessary to regularly check the pH value (optimal = 7.2, tolerance range = 7.0 to 7.4) and adjust it, if

required. For disinfection and oxidation, please use either chlorine products or, alternatively, oxygen components. Never add water care products directly into the pool; instead always use a dosing float or an external chlorine feeder or dosing system. If, for example, chlorine tablets should fall into the water, they can cause permanent damage/discolouration of the liner.

## LINER MAINTENANCE AND CARE

The use of the necessary disinfectants can cause a slight discolouration of the liner over time. Dirt/grease in the upper part, at the level of the water line, can be removed with our edge cleaner; for spring cleaning (with the pool being empty), use our

acidic basic cleaner, which also eliminates limescale deposits. Small holes in the liner can be repaired, e. g. with a repair kit/underwater glue. Add fresh water regularly and change the water completely every 2 years at the latest.

## WINTERIZING

All steel wall swimming pools are winterproof and must be filled over the winter. Lower the water level just below the skimmer; the inlet nozzle can be closed with a cap. In the autumn before wintertime, add a winter preservative to the pool water, so you do not have to change the water in the spring. Never break the ice plates that form on the pool surface, and never step onto or skate on the frozen surface. Damage to the liner may result in loss of water during the winter and thus in a collapse of the swimming pool. It should therefore be checked

regularly. Cover the pool with a winterproof tarpaulin in the autumn. Do not use any boards/planks or other homemade coverings as they may damage your pool. When the water level has been lowered for the winter, ensure that the used cover tarpaulin is sufficiently large to rest on the surface of the water. If a cavity should form under the cover tarpaulin, this may result in bigger damage to the swimming pool (up to a bending of the steel wall) due to the pressure of rainwater.

## WARRANTY CONDITIONS FOR YOUR SWIMMING POOL

We grant a 4-year warranty on the durability of liner and steel wall of your Basic swimming pool (excluding additional accessories such as pump, ladder, etc.), (see warranty table).

### The declining warranty includes the following:

- UV resistance of liner
- Rot-resistance
- Stability of the weld
- Corrosion of the steel wall (no rust film)

### Requirements for asserting a warranty claim:

- The pool must always be installed in accordance with the specifications listed in the assembly instructions.
- You have to submit the sales receipt with legible date that clearly demonstrates which product was bought.
- In case of inground pools, the steel wall must be protected from the outside by waterproof polystyrene (standard pools without warranty for inground installation). A concrete backfill is required in addition.
- A synthetic, rot-proof protective fleece or a floor tarpaulin must be placed on the clean ground, underneath the inside lining.
- The pool is designed for single assembly, and is not suitable for multiple assembly and disassembly.
- Ensure that the protective layer of the steel wall is not damaged during assembly and disassembly.
- Check immediately that all delivered parts are complete.

### General warranty conditions:

- A standstill or want of use of the purchased good during a waiting period, either for the supply of parts that were missing in the supply of the pool, or for repair or replacement, does not give reason to rent material and does not entitle to any contractual compensation whatsoever.
- The warranty is limited to either shipping to allow replacement of parts identified as defective by our experts, or the repair of that part(s), which is at the discretion of our experts. Under no circumstances can such parts give reason for any refund.
- When using products from other manufacturers which are not compatible with our items/products, we reserve the right to fulfil warranty claims.
- Transport costs are to be borne by the owner of the objected goods.
- All additional costs associated with the replacement or repair of the parts identified by our experts as defective, such as labour, travel, demounting, packaging, transport, standstill, inspection, pool cleaning, reconstruction, loss of water or replacement, treatment chemicals, etc., as well as the risk, are always to be borne by the owner and are not covered by the warranty.
- Regular checks and fastening of all screw connections (dependent on model).
- In case of a free replacement delivery, this does not lead to an interruption of the period of limitation in accordance with §212 BGB (German Civil Code).

## WARRANTY EXCLUSION

- Mechanical damage of any kind.
- Rust film and damage to the steel wall due to the installation of components.
- If repairs are carried out by a third party that has not been authorized by the manufacturer or its subsidiaries. Damage and consequential damage caused, for example, by incorrect use of water care products.
- Incorrect assembly, including incorrect assembly of components, or parts that are incompatible with the materials used in our products.
- Normal wear and tear.
- The pool must never be winterized without water, no abnormal use (e.g. ice skating) permitted.
- Also excluded are personal injuries, damage caused by natural disasters (flooding, wind, etc.), damage due to a faulty condition of the ground (movement, sinking, slipping, groundwater, etc.), damage caused by external factors.

## 4-YEAR DEGRESSIVE WARRANTY

Period	Percentage value	Amount to be paid for required spare part
within 2 years	100 %	full warranty
from 3rd year	75 %	25 %
from 4th year	50 %	50 %

### PHOTO COMPETITION

Please send photos of your completed pool to:  
[service@waterman-pool.com](mailto:service@waterman-pool.com)  
They will be rated and may even win a prize, provided we can use them for advertising purposes.

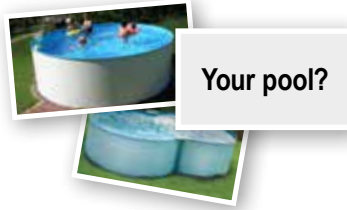

To ensure a prompt, trouble-free and uncomplicated processing of your complaint, it is important that the registration form is completely filled out in block letters and submitted together with all required documents (proof of purchase or sales receipt/photos). A proof of purchase like a sales receipt is a mandatory prerequisite for all warranty claims. Without proof of purchase, it is unfortunately not possible for us to acknowledge/process a complaint. Relevant photos regarding your complaint will help us to evaluate the facts more quickly. This will save both you and us unnecessary costs and waiting times/delays.

**By post to:** Waterman Customer Service  
Bahnhofstr. 68, 73240 Wendlingen/Germany  
**By fax to:** + 49 (0) 7024/4048-667  
**By E-mail to:** [service@waterman-pool.com](mailto:service@waterman-pool.com)



You can download the registration form here:  
<http://reklamation.waterman-pool.com>

waterman

# Registration of a complaint

**Waterman Customer Service**  
Bahnhofstr. 68  
73240 Wendlingen/Germany  
Tel.: + 49 (0) 7024/4048-666  
Fax: + 49 7024/4048-667  
E-mail: [service@waterman-pool.com](mailto:service@waterman-pool.com)

**It is imperative that you attach a proof of purchase\* to your claim!** (A proof of purchase like a sales receipt is a mandatory prerequisite for all warranty claims. Without proof of purchase, it is unfortunately not possible for us to acknowledge/process a complaint).

**Please attach relevant photos\* of the damage to your complaint!** (Photos of defective item.) These allow us to better evaluate the facts. In addition, the complaint can be processed faster and unnecessary costs and waiting times are avoided for all involved.

## Your contact data

Name\*

Address\*

Postcode/City\*

Phone\*

Mobile

Fax

E-mail\*

I bought the product (model) \_\_\_\_\_ with article number \_\_\_\_\_  
from (company) \_\_\_\_\_ at (Postcode/Town) \_\_\_\_\_ on \_\_\_\_\_

I want to submit the following complaint (Please include a precise description):  
\_\_\_\_\_  
\_\_\_\_\_  
\_\_\_\_\_  
\_\_\_\_\_  
\_\_\_\_\_

Place\* \_\_\_\_\_ Date\* \_\_\_\_\_ Signature\* \_\_\_\_\_

\*Required information/documents

---

## CUSTOMER SERVICE

Thank you for purchasing one of our products. Even though our products are subject to stringent final quality checks, malfunctions or defects cannot be excluded and may occur. If, contrary to expectations, the purchased product should not function properly or should otherwise not be in good order, please contact our customer service directly.

As a matter of course, our customer service is available for you also after the warranty period.



**PLEASE DO  
NOT RETURN TO  
THE STORE!**

**Questions? Problems? Missing parts?**  
Please contact our customer hotline if you need any help.

**Waterman Customer Service**  
**Bahnhofstr. 68, 73240 Wendlingen/Germany**  
**Tel.: +49 (0) 7024/4048666**  
**Fax: +49 (0) 7024/4048667**  
**E-mail: [service@waterman-pool.com](mailto:service@waterman-pool.com)**

---